

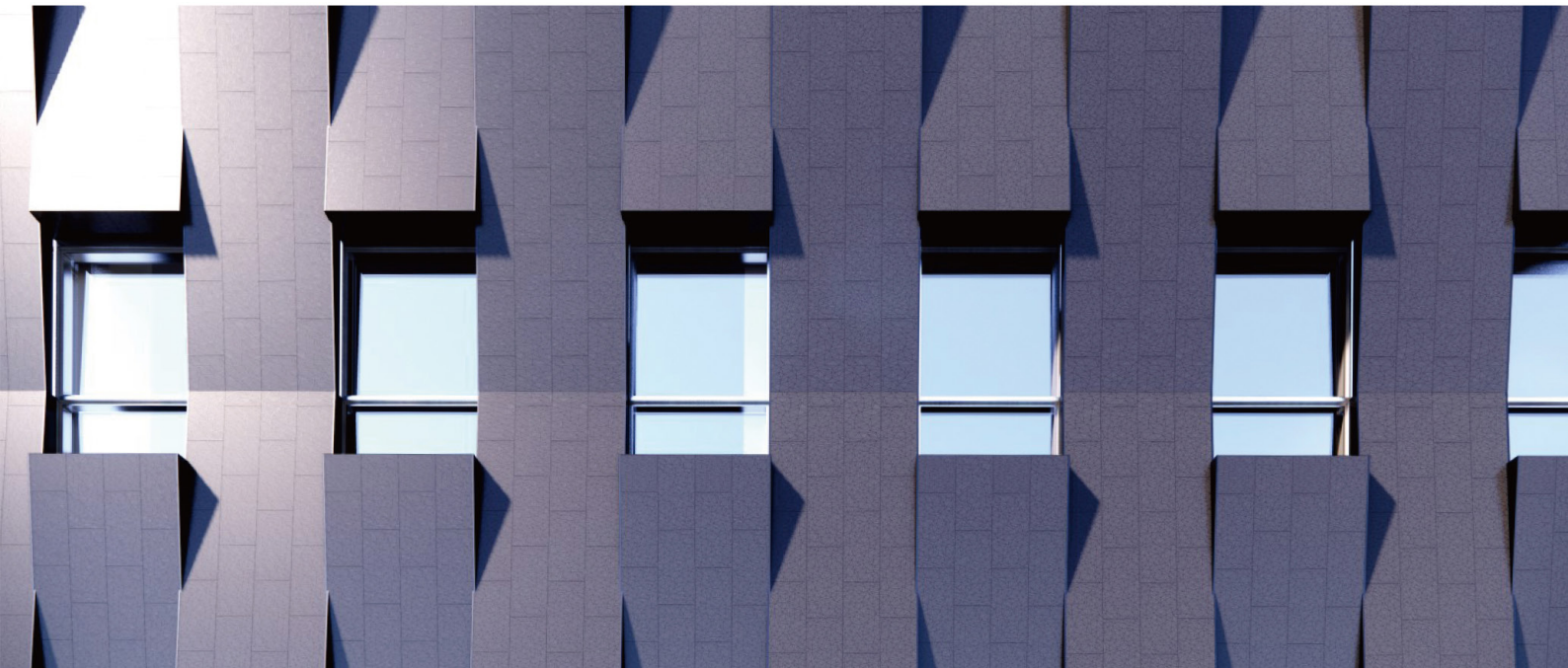

BYUCKSAN

MOZAIK

신개념 공법 모듈 디자인 패널



벽산 모자이크

벽산 모자이크 패널은 기존 알루미늄계 시트 패널의 단점을 극복한 건식 패널입니다. 잉크젯 프린팅으로 다양하고 미려한 마감 연출이 가능하며 내후성을 극대화하여 시공 후의 오염을 방지합니다. 또한 신개념 공법인 클립 고정식 부착으로 시공성을 향상시켰으며 단열 일체형 제품으로 원가 절감에 탁월합니다. 모자이크 패널의 핵심 기술인 Deep Drawing 가공 공법은 모서리 부위의 Round 처리를 통해 월등한 마감 품질과 안전성, 시공성을 부여합니다.

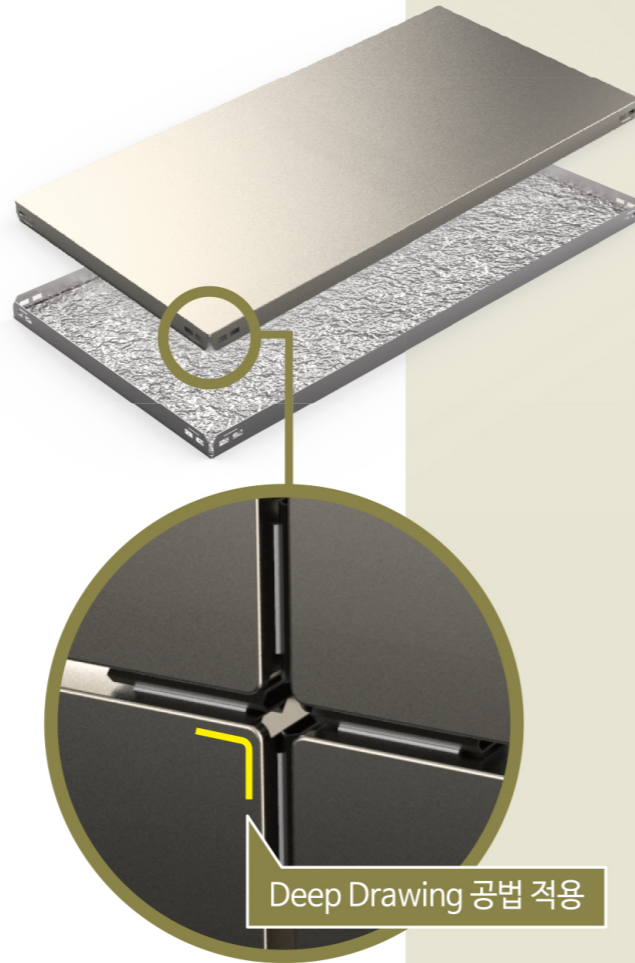

Deep Drawing 공법 적용



MATERIAL

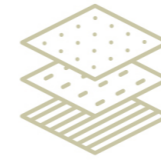
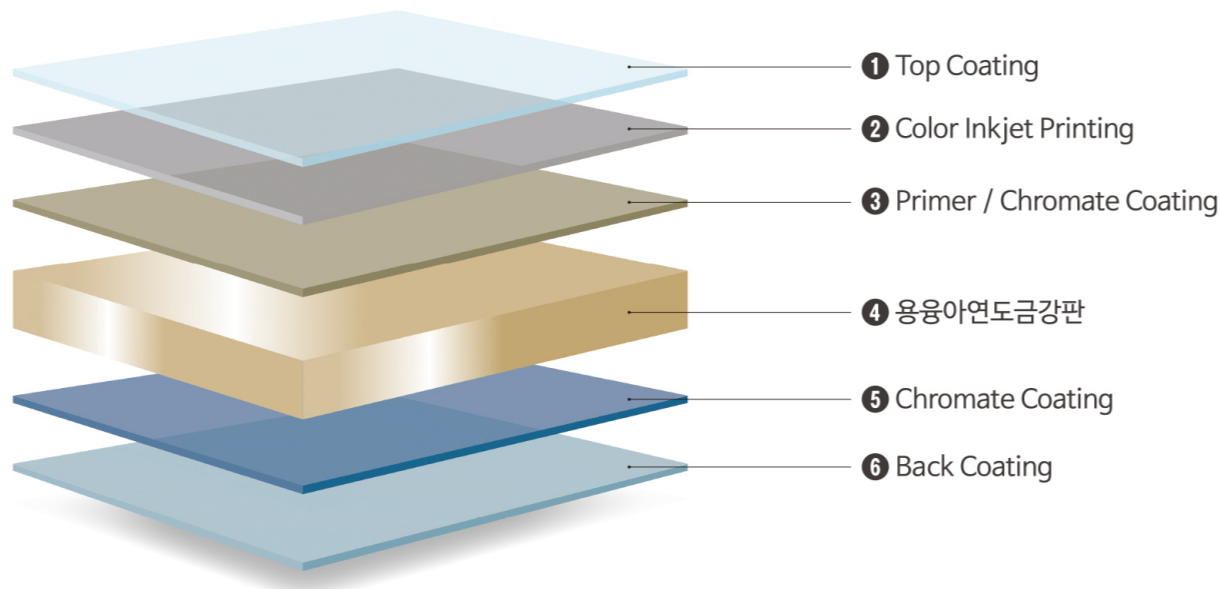

DESIGN CONCEPT

- 외장 마감재 + 모자이크 패턴 + 자유 디자인
- 300/600mm 모듈 기반의 다양한 형태 조합
- 잉크젯 프린팅 디자인으로 기하학적 패턴 연출
- 금속계열 외장 마감재의 새로운 패러다임 제시
- 고기능성 소재를 통한 Luxury Image 구현



TECHNICAL STRENGTH

- 제품의 경량화 7kg/m²
- 무용점 건식 공법의 내진 구조 구현
- 슬림한 줄눈(4mm)으로 마감의 일체화
- 오픈조인트 공법 도입 (인테리어)
- 불연 / 준불연 등급의 난연성능

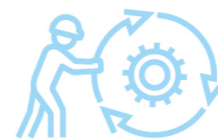

PRICE COMPETITIVENESS

- 모듈화, 자동화를 통한 원가 절감 (약 40%)
- 시공의 단순화를 통한 인건비 절감
- 제품의 경량화를 통한 운반비 절감
- 스테드(하지철물) 조립공법 개발
- 공기 단축을 통한 관리비용 절감



SPECIFICATION

- 모자이크 컨셉을 통한 디자인 특화
- 합리적 가격 경쟁력 확보
- 제품 마감의 미적 완성도 증대 / 고급화
- 유사 자재(AL 복합판넬 등)가 모방할 수 없는 디자인 및 단가



SYSTEM DETAIL

MOZAIK

하지철물 및 패널 시공 (평면)

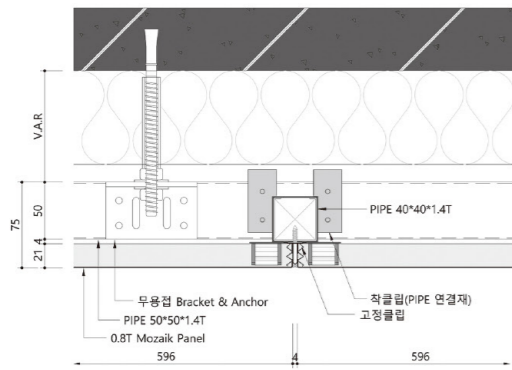

패널 고정 (평면)

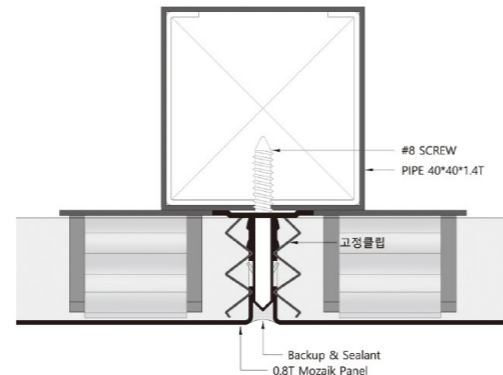

코너 시공 (평면)

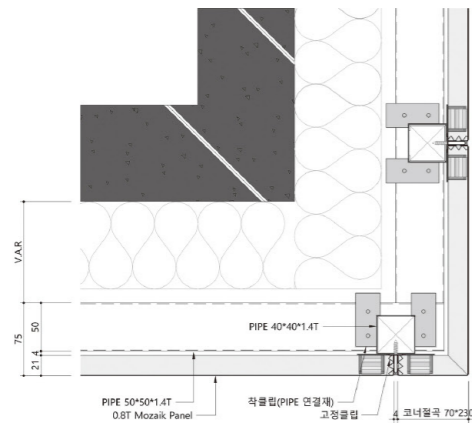

두겹 후레싱 (단면)

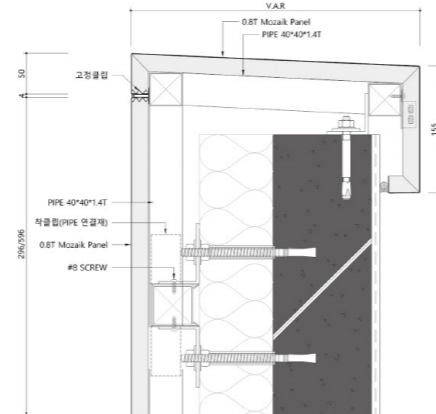

창호 후레싱 (평면)

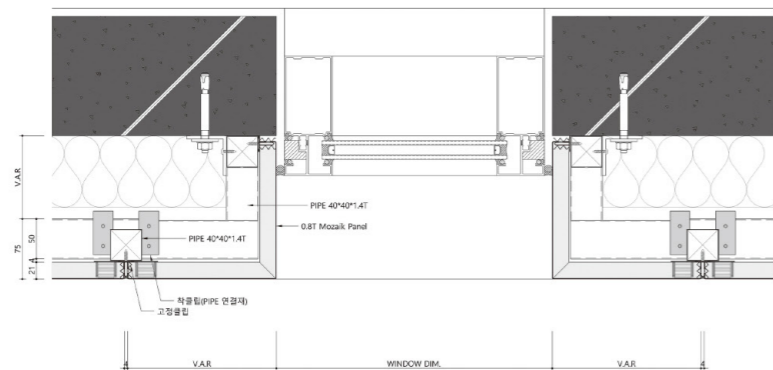

INSTALLATION

MOZAIK

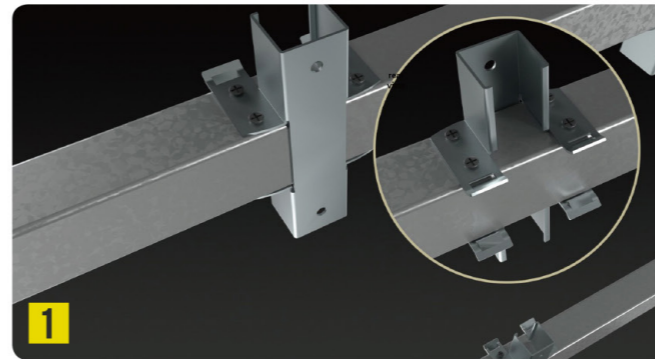

수평 m-PIPE 및 MZK커넥터 체결

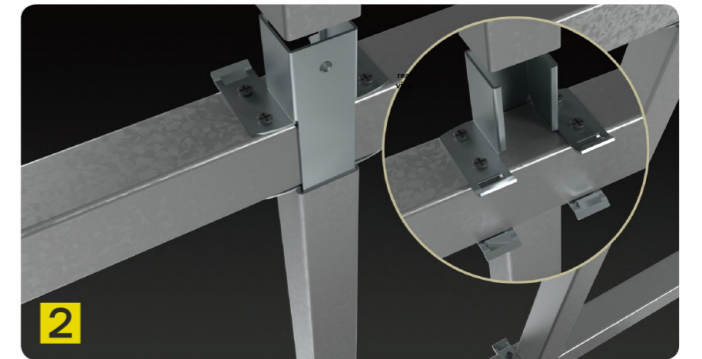

커넥터 상, 하단부 수직 m-PIPE 접합

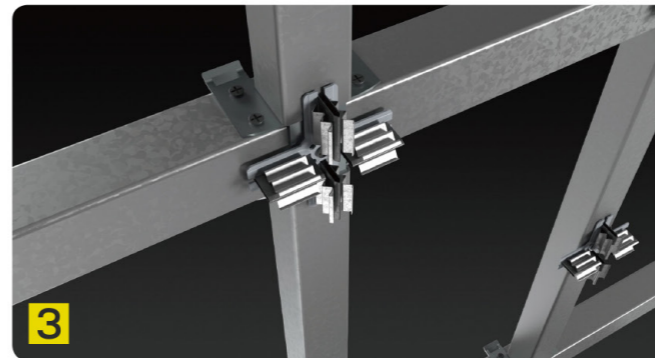

수직 m-PIPE 및 MZK클립 피스 고정



MZK클립 고정부위 모자이크패널 시공



MZK클립 고정부위 모자이크패널 시공

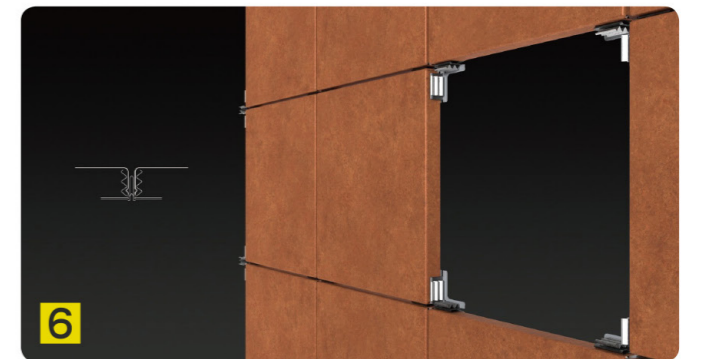

MZK클립 고정부위 모자이크패널 시공

MZK 커넥터



MZK 클립

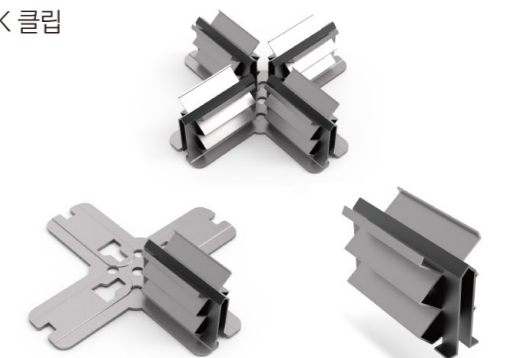



PATTERN

MOZAIK



G0S101S Beige Stone Light (WS)

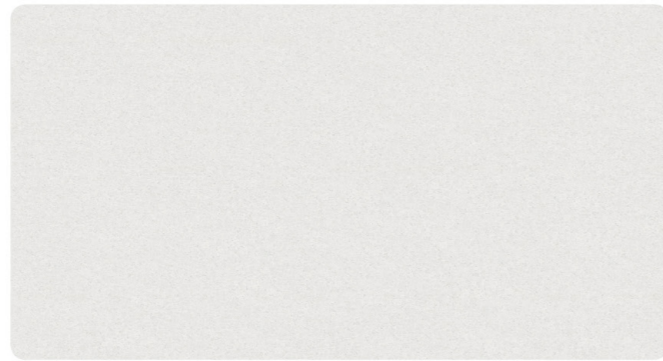

G7S091S White Stone (WS)



G6R101S Terracotta Wall Red (WS)

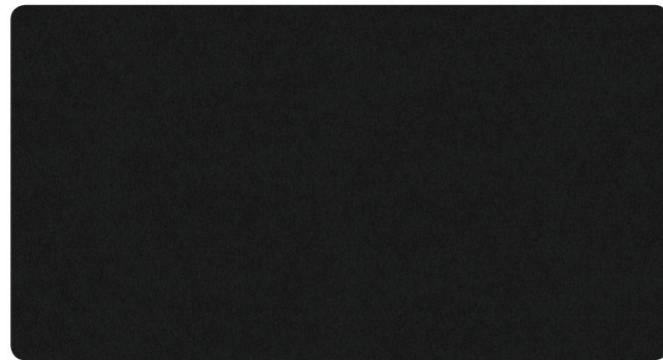

G9F651P A.Zinc Black Metal (WS)



IPA01 Imprinting Black

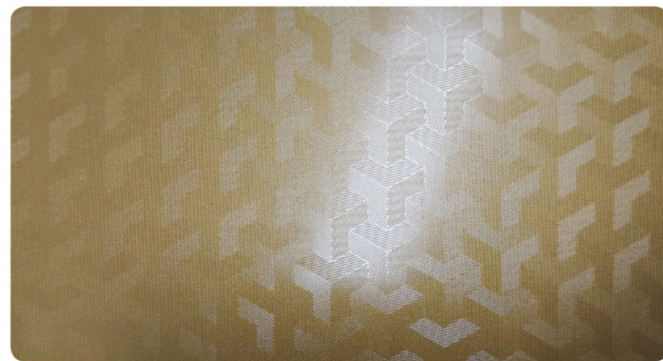

IPR01 Goyard

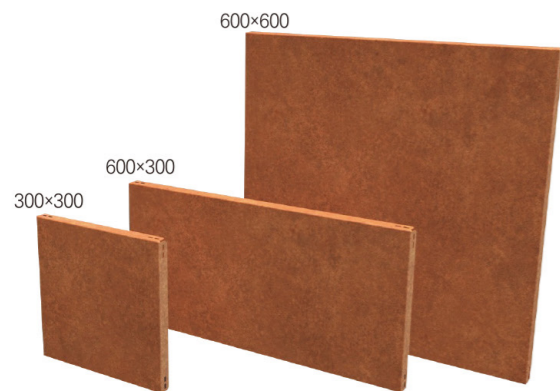

PATTERN

MOZAIK



벽산 모자이크 패널은 **고성능 프린팅 시스템**을 통해
미려하고 다양한 마감을 연출합니다.

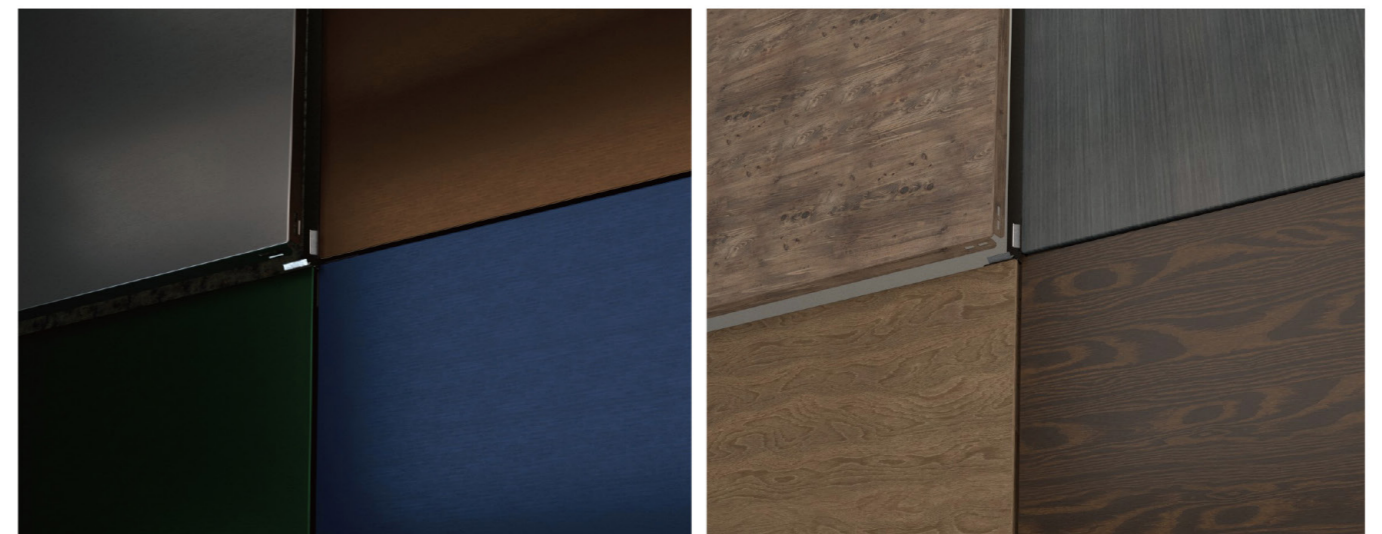



CONSTRUCTION

MOZAIK



경북 경산 영남대 정보전산원

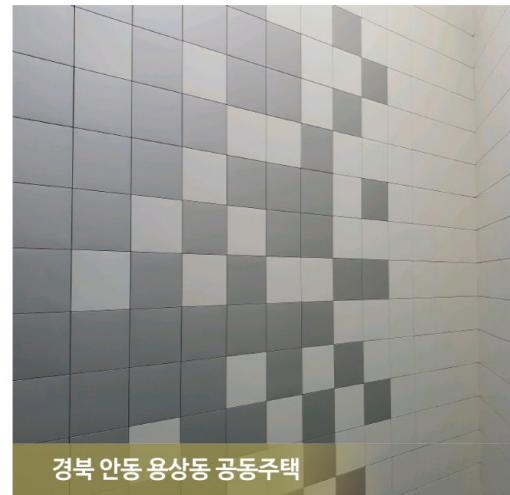

경북 안동 용상동 공동주택

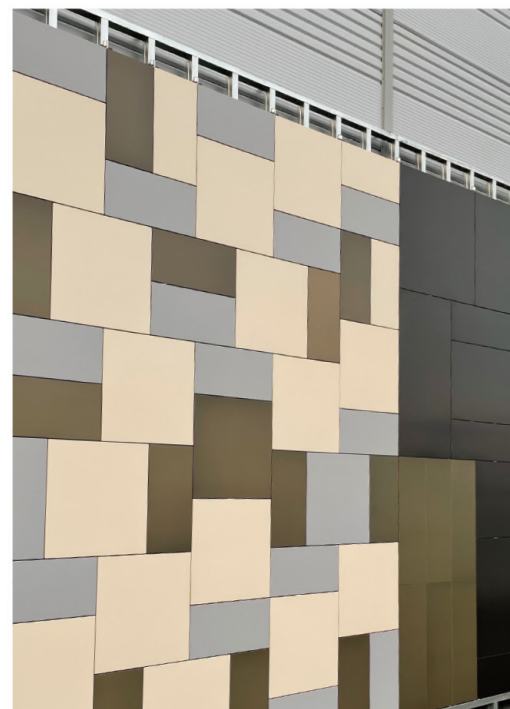
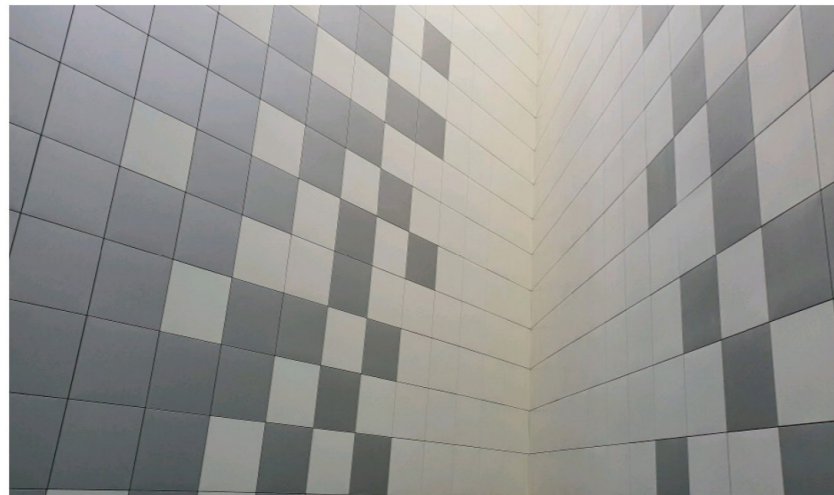

CONSTRUCTION

MOZAIK



코리아 빌드 전시

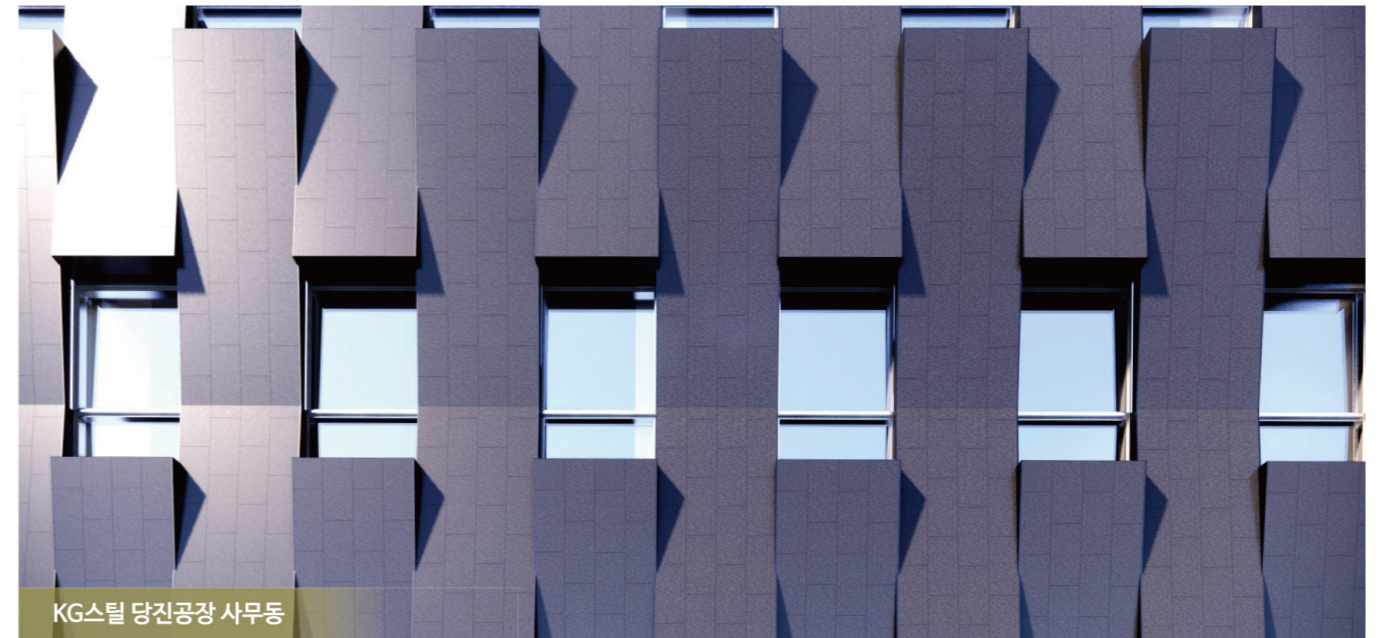

KG스틸 당진공장 사무동



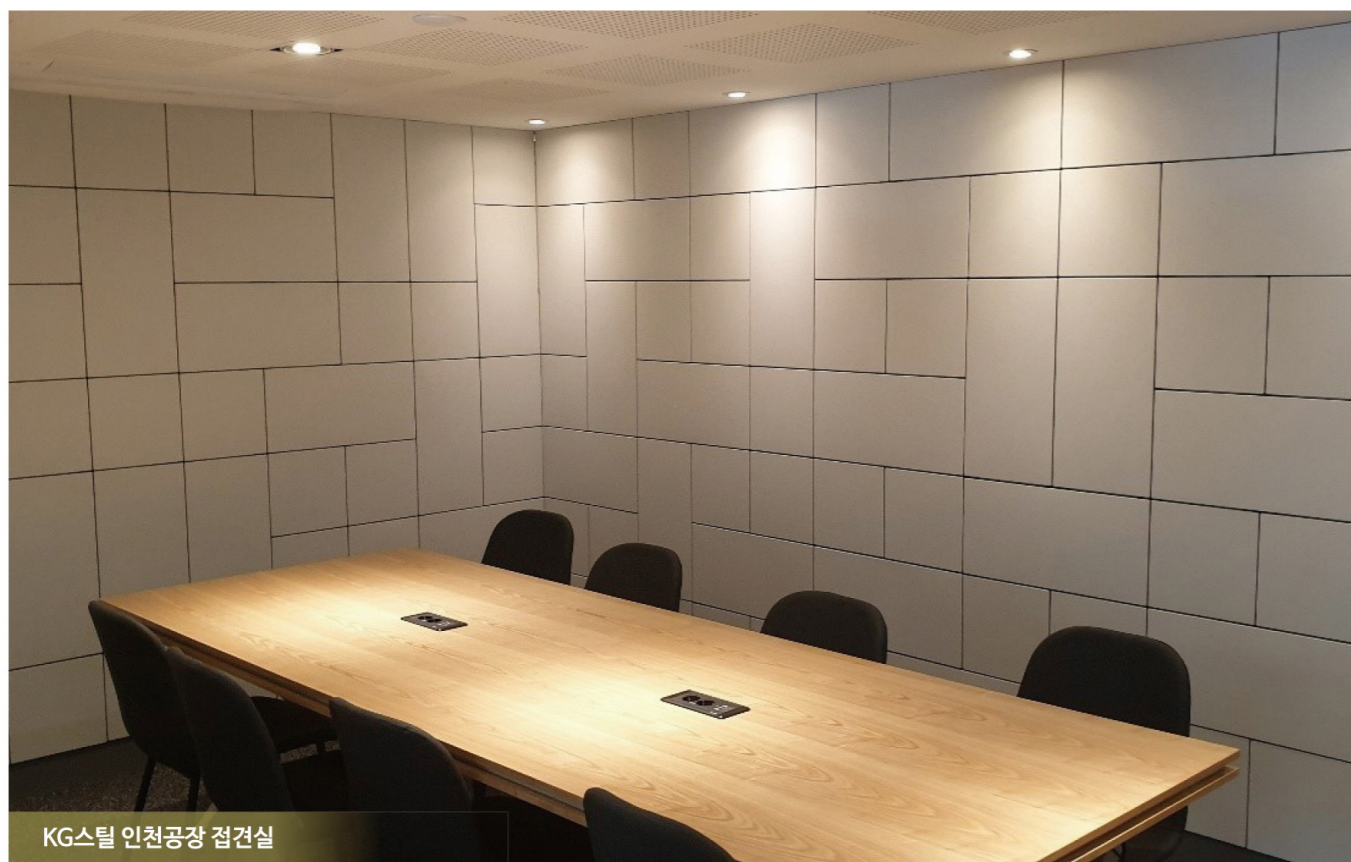

KG스틸 인천공장 접견실

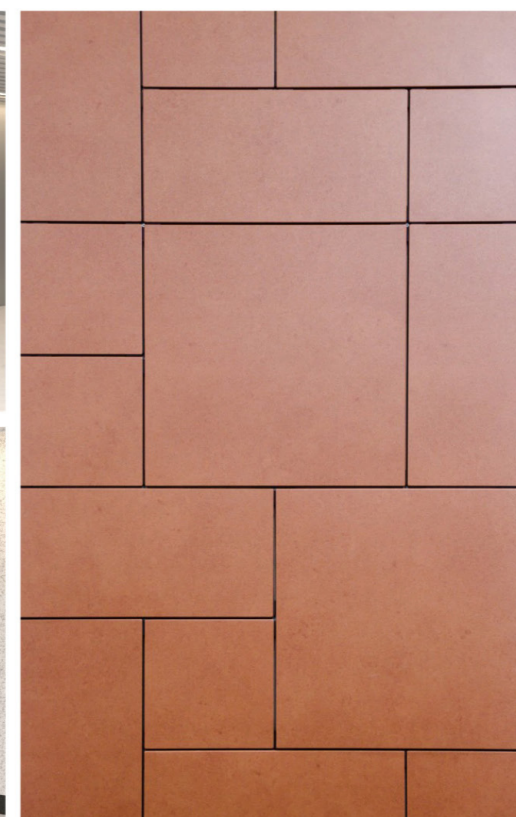



CONSTRUCTION

MOZAIK

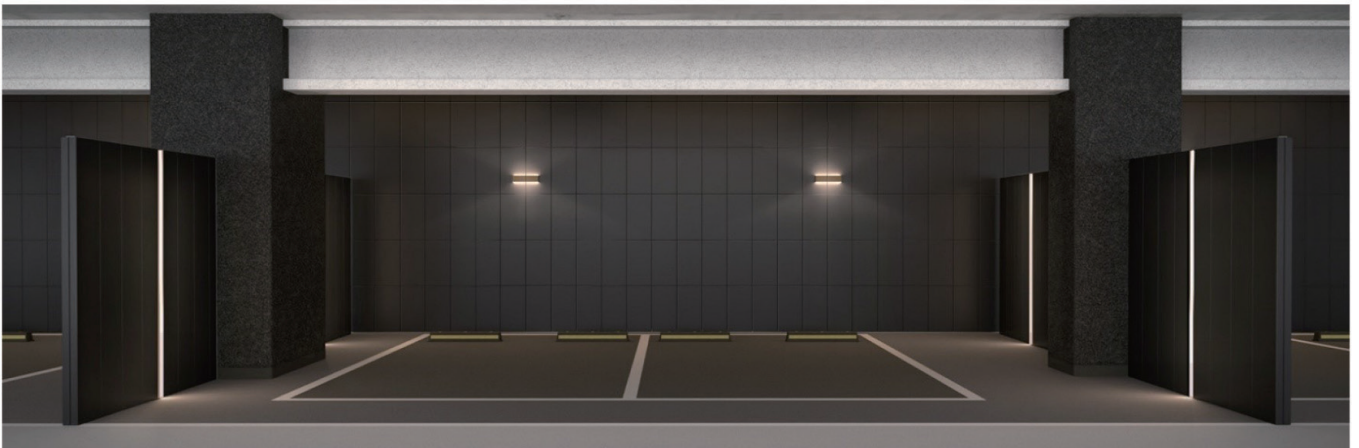
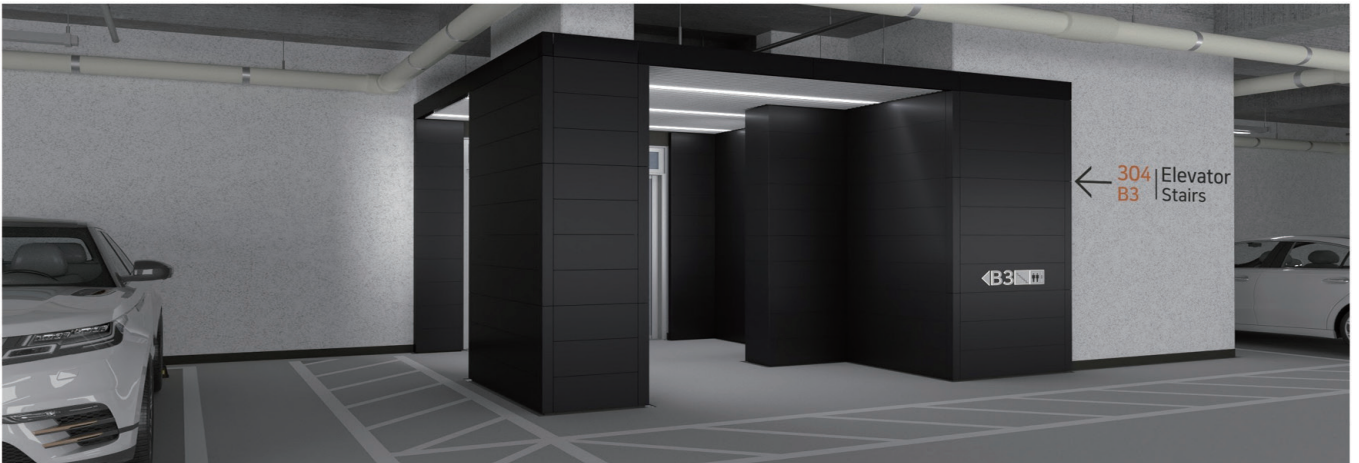

| 판매원 |



서울시 중구 퇴계로 307 광희빌딩
상품개발운영팀 : 02-2260-6263
www.byucksan.com

| 제조원 |



경북 성주군 선남면 명관로 429-6
본 사 : 02-335-3798
대구지사 : 053-424-0014
www.ventwall.com